

# AUDIX

## RAD-360

### True Diversity Wireless Microphone System



Thank you for choosing the Audix RAD-360! This product was designed to provide you with many years of reliable service. Please read this manual before using the system to familiarize yourself with its operation.

# Table of Contents

Introduction	.2
Types Of Transmitters	.2
Frequency Groupings	.3
Important Items	.3
Unpacking	.4
Description Of Receiver	.5-6
Description Of Handheld Transmitter	.7
Description Of Bodypack	.8
Setting Up The Receiver	.9
Connecting The Power	.9
Connecting Antennas	.9
Connecting The Receiver	.10
P.A. Application	.10
Guitar Application	.10
Battery Installation	.11
Setting The Frequency On The Receiver	.12
Setting The Frequency On The Handheld Transmitter	.13
Setting The Frequency On The Bodypack	.14
Locking/Unlocking The Receiver	.15
Locking The Handheld Transmitter	.16
Unlocking The Handheld Transmitter	.17
Locking/Unlocking The Bodypack	.18
Adjusting Sensitivity On The Handheld Transmitter	.19
Adjusting Sensitivity On The Bodypack	.20
Using The Bodypack	.21-22
Using The Scan Feature On The Receiver	.23
Battery Life Indicators	.24
Performance Tips	.25-26
Troubleshooting	.27
Specifications	.28-30

## **INTRODUCTION:**

Wireless microphones have risen in popularity in the last several years. With the improved technology available today, your Audix wireless system is able to offer excellent sound quality and reliable performance for a wide range of applications ranging from Houses of Worship to professional concert stages.

While it is true that wireless systems allow for greater freedom of movement, they have also introduced a new set of performance challenges. This section is intended to give you some guidelines to ensure optimal performance with your Audix Wireless System.

### **Types of transmitters:**

- 1. The handheld:** The handheld is just what it sounds like. It looks similar to your wired handheld mic you use on stage, and acts the same, except no wires!
- 2. The Bodypack:** The Bodypack is a transmitter you wear clipped to your clothing. There are a variety of different mic options to plug into the Bodypack. These include; a lavalier (also known as a lapel mic), a headset mic, and a clip-on mic for saxophone or brass instruments. An adapting cable is available for use with guitar or bass. Audix has all of these options available.

### **RF:**

All wireless mics work on Radio Frequencies (RF). Whether in the VHF or UHF band, all transmission of wireless information is via RF. The Audix RAD 360 is in the UHF band with 193 user selectable frequencies in 3 different frequency groups.

Care and consideration must be given in the positioning of the receiver as well as the transmitter. Metal in your walls, large numbers of people, other wireless mics, TV stations, radio stations, distance, and battery strength are among the things that can interfere with RF transmission.

**Frequency Groupings:**

- A. 692MHz – 716MHz
- B. 782MHz – 806MHz
- C. 638Mhz - 662Mhz

**Important Items:**

1. **Never open up the receiver! Doing so will void the warranty and may expose you to potential electrical hazards.**
2. **Always un-plug the receiver prior to moving it to a new location.**
3. **If you are not planning to use the system for a long period of time, Audix recommends that you remove the batteries from the transmitter.**
4. **Do not expose the units to direct sunlight or heat sources such as an electric heater.**
5. **Do not expose the units to excessive moisture or submerge them in water**
6. **If it becomes necessary to clean your RAD 360 System, use a clean damp cloth for this purpose. Do not use cleaning agents or solvents.**

## **UNPACKING YOUR RAD-360:**

Before beginning installation of your Wireless System, please check the list on the side of your packing box for contents and be sure all the components are included. Your system should include a combination of the following components:

- 1. (1) RAD 360 Receiver**
- 2. (1) RAD 360 Transmitter.** This may be either a Handheld or Body pack Transmitter.
  - a)** If you have purchased a Bodypack system you will also have one (1) mic to be plugged into the Bodypack.
  - b)** If you purchased the guitar system, you will receive one (1) guitar cable to plug into the Bodypack.
- 3. (1) Power Supply**
- 4. (2) Antennas**
- 5. (1) Rack Mount Kit and screws**
- 6. (1) Padded carrying case**
- 7. (1) 1/4" - 1/4" audio patch cable**
- 8. (1) Screwdriver for changing settings on the Bodypack**

Once you have verified each of these components is present, you are ready to begin the installation of your RAD 360 System.

## Description of RAD-360 Receiver (front)

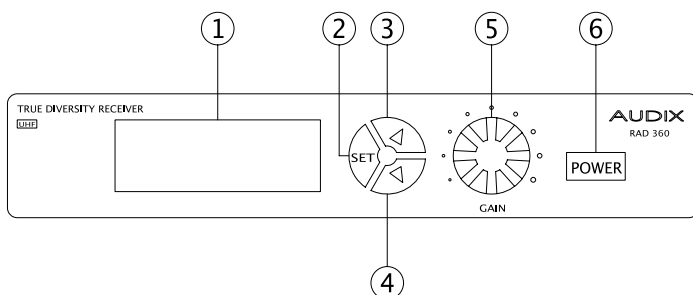

### Front Panel:

- 1. LCD Display Screen:** Displays status of both Transmitter and Receiver including Channel, RF level, Audio Level, and Battery life.
- 2. SET button:** This button is used to change and store settings.
- 3. UP button:** Changes parameter “up” or increase
- 4. DOWN button:** Changes parameter “down” or decrease
- 5. GAIN control knob:** Controls output of signal to mixer/preamp.
- 6. POWER switch**

## Description of RAD-360 Receiver (back)

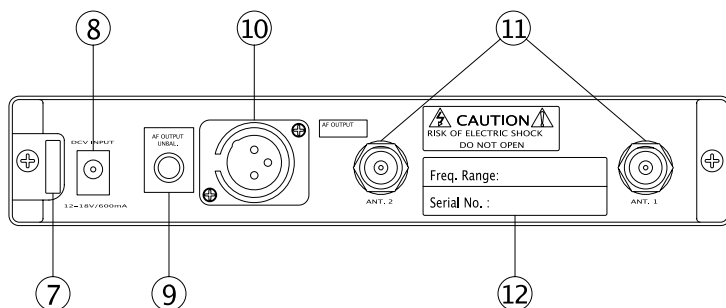

### Back Panel:

- 7. STRAIN RELIEF for power cable:** Prevents power cable from being pulled out.
- 8. POWER PLUG input:** Always use included power supply. Use of any other power supply other than the one provided may damage your unit and void your warranty.
- 9. UNBALANCED AUDIO OUT:** Provides an unbalanced output from receiver to audio mixer.
- 10. BALANCED XLR AUDIO OUT:** Provides a balanced output from receiver.
- 11. ANTENNA SOCKETS:** Connects either antenna or extension cable.
- 12. SERIAL NUMBER:** Please retain for your records and warranty.

# Description of RAD-360 Handheld Transmitter

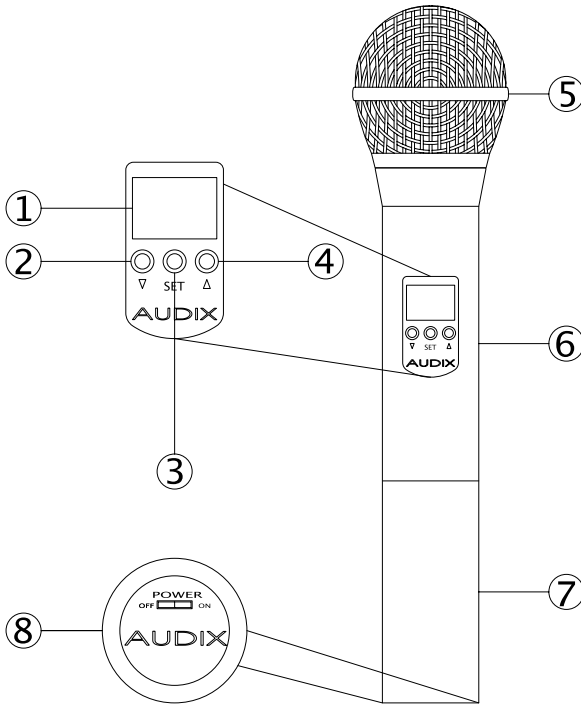

- 1. LCD Display Screen:** Displays status of transmitter including Channel and Battery Life.
- 2. DOWN button:** Changes parameter “down” or decrease.
- 3. SET button:** This button is used to change and store settings.
- 4. UP button:** Changes parameter “up” or increase.
- 5. GRILL:** Constructed of extremely durable spring steel to resist scratches and dents.
- 6. BODY**
- 7. BATTERY COMPARTMENT COVER**
- 8. POWER SWITCH:** Also functions as a mute switch.



# Description of RAD 360 Bodypack Transmitter

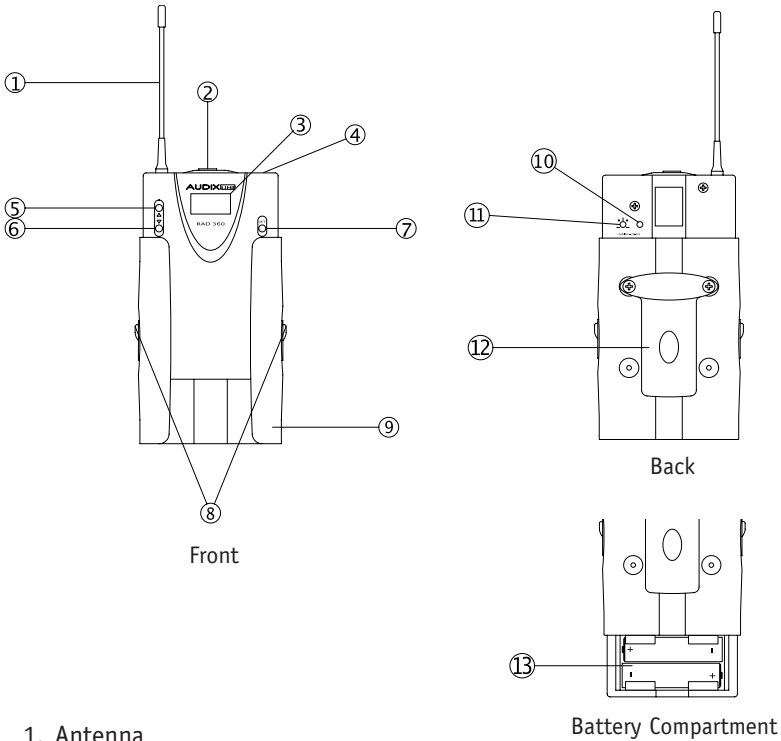

1. Antenna
2. Power switch
3. LCD Display Screen: Displays status of transmitter including Channel and Battery Life.
4. Mic or guitar cable connector
5. UP button: Changes parameter "up" or increase.
6. DOWN button: Changes parameter "down" or decrease.
7. SET button: This button is used to change and store settings.
8. Sliding cover latches
9. Sliding protective metal cover
10. Three position pad
11. Gain potentiometer 20dB
12. Belt clip
13. Battery compartment (note polarity)

## Setting up the Receiver

### Connecting Power:

Begin by looping POWER CABLE through STRAIN RELIEF (fig. 1). This will prevent cable from being pulled from socket during operation. Plug POWER CABLE into POWER SOCKET (fig. 2). Connect to power source.

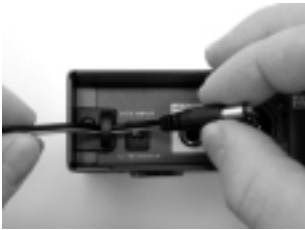

fig. 1



fig. 2

### Connecting Antennas:

Line slots on ANTENNA up with ANTENNA BNC SOCKET on back of unit (fig. 3). Push ANTENNA on and twist clockwise to lock using knurled section of ANTENNA (fig. 4).



fig. 3



fig. 4

### Connecting the Receiver:

The Audix RAD 360 features balanced and unbalanced outputs to allow you to connect it to a wide variety of audio and instrument sound systems:

#### P. A. Application:

Connect the audio output of the RAD 360 Receiver to the audio input of your PA system using a balanced (XLR) or unbalanced (1/4") cable (not included).

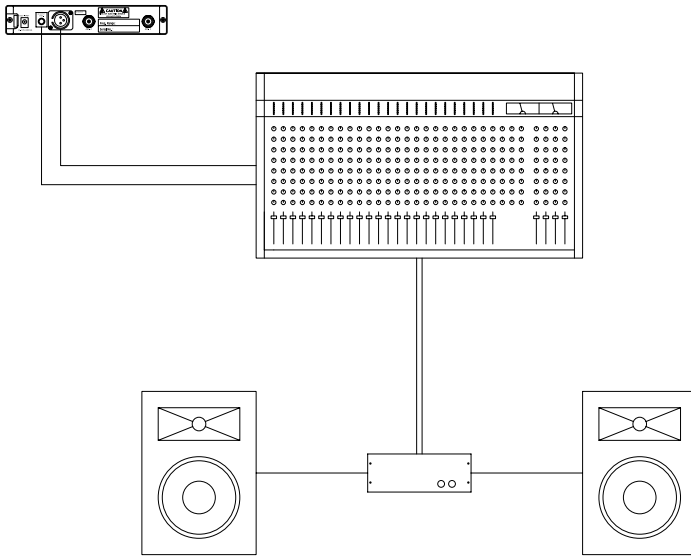

#### Guitar Application:

Connect the unbalanced (1/4") output of the RAD 360 Receiver to the input of the guitar amplifier.

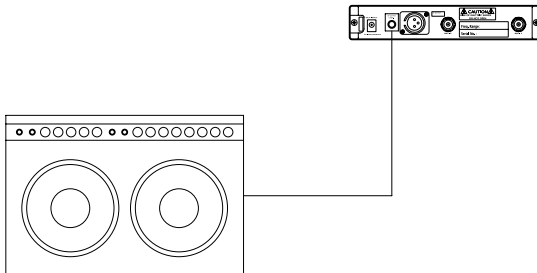

## Battery Installation

The RAD 360 transmitters require (2) AA batteries to operate. Please observe the polarity markings in the compartment to ensure proper operation. Always use batteries of the same make and age to prevent possible damage to the transmitters.

**Handheld battery installation:** Unscrew base of handheld and remove sleeve, exposing battery compartment.

**Bodypack battery installation:** Press latches on both sides of transmitter and slide aluminum sleeve up, exposing battery compartment.

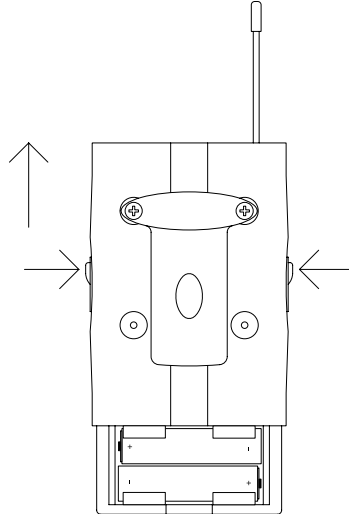
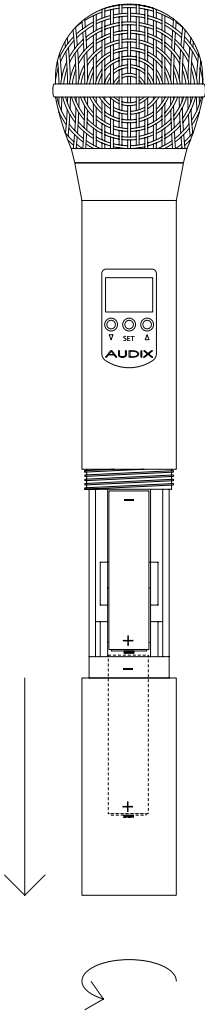

## Setting the Frequency on the RAD-360 Receiver

1. Power the system up. From the startup screen, press and hold the SET button until you see the word "FREQUE".

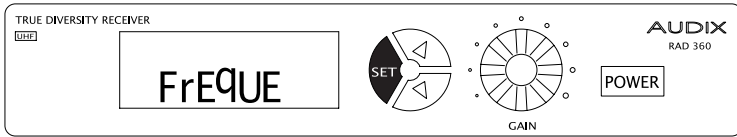

2. Use the UP and DOWN buttons to set the desired frequency.

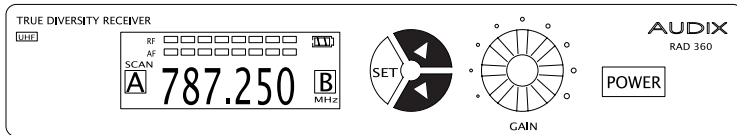

3. Press SET to store.

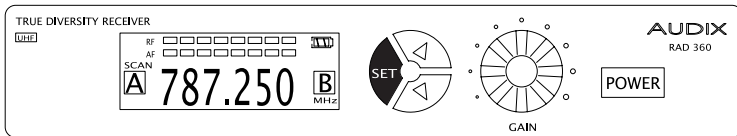

**Important:** Be sure to set the transmitter and receiver on the same frequency. The frequencies need to match in order for the system to work.

# Setting The Frequency on the RAD-360 Handheld Transmitter

1. From the startup screen, press and hold the SET button until you see the word "FREQUE". Be patient as it will take approximately 2 seconds for this function to trigger. The "MHz" in the upper right hand corner of the display will start to blink.

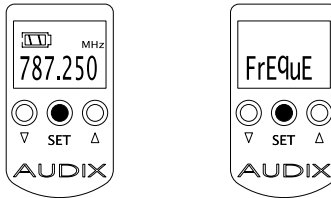

2. Use the UP and DOWN buttons to set the desired frequency to match the receiver. The "MHz" in the upper right hand corner of the display will continue to blink.

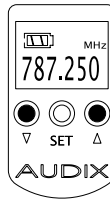

3. Press SET to store. The "MHz" will stop blinking.

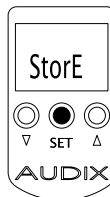

**Important:** Remember that only one transmitter at a time may be used with one receiver. In order to operate two transmitters simultaneously you will need to have two receivers, and so on.

# Setting The Frequency on the RAD-360 Bodypack Transmitter

1. From the startup screen, press and hold the SET button until you see the word "FREQUE". The "MHz" in the upper right hand corner of the display will start to blink.

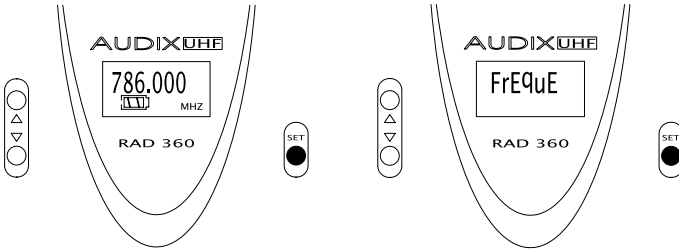

2. Use the UP and DOWN buttons to set the desired frequency. The "MHz" in the upper right hand corner of the display will continue to blink.

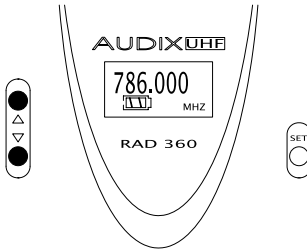

3. Press SET to store. The "MHz" will stop blinking.

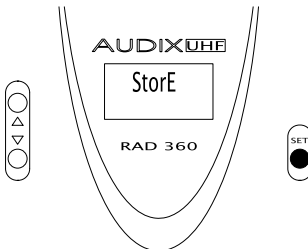

**Important:** Remember that only one transmitter at a time may be used with one receiver. In order to operate two transmitters simultaneously you will need to have two receivers, and so on.

# Locking/Unlocking RAD-360 Receiver

**Locking the receiver will prevent changes to the settings.**

1. Press and hold the UP button until you see the words "LOC ON".  
Once the unit is locked, you will not be able to change parameters or power down until the unit is unlocked.

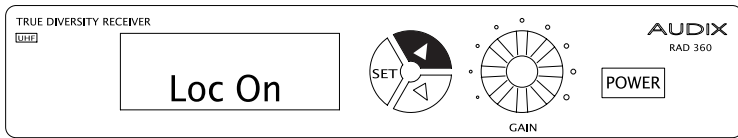

2. To unlock, press and hold the UP button until you see the words "LOC OFF".

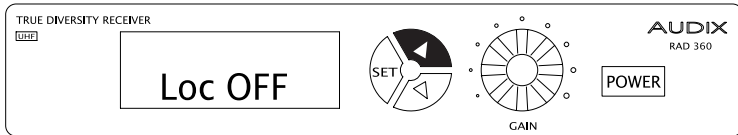



## Locking the RAD-360 Handheld Transmitter

1. From the startup screen, press and hold the SET button until you see the word “FREQUE”.

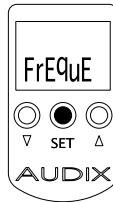

2. Press SET once again and you will see “SENSIT” on the display.

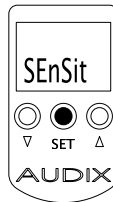

3. Press SET again to display “LOCOFF”. Press the Up button to set it to “LOCON” to activate the lock.

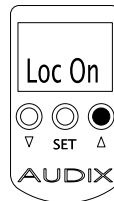
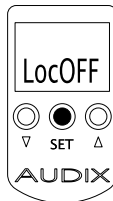

4. Press SET to store.

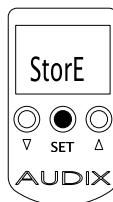

## Unlocking the RAD-360 Handheld Transmitter

1. From the startup screen, press and hold the SET button until you see “LOCON”.

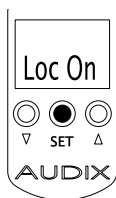

2. Press the Down button to change to “LOCOFF”.

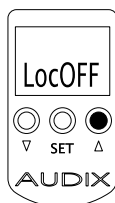

3. Press SET to store.

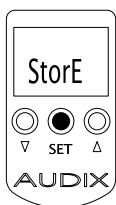

## Locking/Unlocking the RAD-360 Bodypack Transmitter

1. Press and hold the UP button until you see the words "LOC ON".

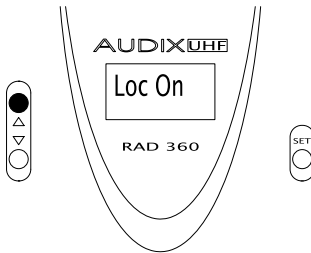

To unlock, press and hold the UP button until you see the words "LOC OFF".

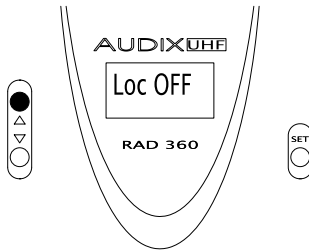

# Adjusting the Sensitivity on the RAD-360 Handheld Transmitter

The RAD 360 Handheld features adjustable sensitivity to increase/decrease the output stage of the microphone. This helps to improve gain before feedback and to prevent overloading the mixer/preamp.

1. From the startup screen, press and hold the SET button until you see the word "FREQUE".

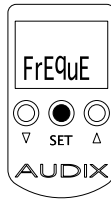

2. Press SET once again and you will see "SENSIT" on the display.

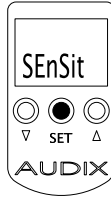

3. Press either UP or DOWN to adjust the output of the transmitter from -0 db to -24 db. Use the "AF" bar graph on the Receiver to gauge your settings.

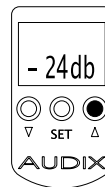
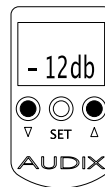
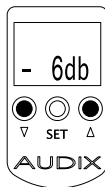
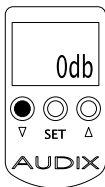

4. Press SET to store.

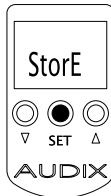

# Adjusting the Sensitivity on the RAD-360 Bodypack Transmitter

The RAD 360 Bodypack features adjustable sensitivity to increase/decrease the output stage of the audio source. This helps to improve gain before feedback and to prevent overloading the mixer/preamp. Audix supplies a miniature screwdriver for the purpose of changing the gain and pad settings.

Please note that Audix ships the bodypack transmitter with the pad at "0" (zero) and the gain at the 12:00 o'clock position.

The pad allows you to control the input sensitivity of the microphone you are using with the bodypack. Start out at zero and adjust accordingly. The gain setting allows you to increase or decrease the output level of the microphone.

**For guitar:** Start with the pad at -20, and the gain at "0" (zero). Further adjustments will depend on the output level of the guitar.

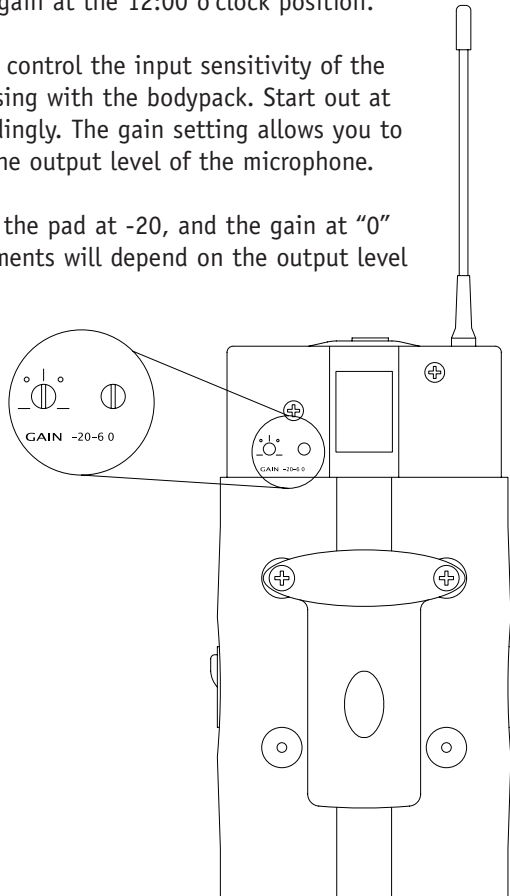

## Using the Bodypack Transmitter

You will have one of four possible options with the Bodypack Transmitter. They are:

1. Lavalier or Lapel microphone
2. Headset microphone
3. Horn/sax microphone
4. Guitar/Bass Cable

Audix uses a common mini 3-pin XLR(f) connector to connect the microphone cable to the Bodypack. The following information will instruct you on how to connect the microphone to the Bodypack and achieve the best performance from the microphone:

1. Insert mini 3-pin XLR connector into the top of the RAD360BP. This will be the same regardless of the type of mic option you have. You will feel the connector connect by a soft “pop” as you push it in. Do not pull on the wires of the microphone to change mics from the Bodypack. Make sure to depress the small black button on the side of the connector, and only pull on the connector itself to remove the mic from the Bodypack. Pulling on the wires will damage the connection and result in crackling and poor quality sound.
2. Install the batteries into the back of the Bodypack paying attention to the polarity direction.
3. Turn the transmitter on and match the frequency to the receiver.
4. When using a lavalier microphone, care and consideration must be used regarding the positioning of the microphone. Ideally the microphone should be placed approximately 6 inches under the chin of the user and centered underneath the mouth. This will lessen the “race-track” effect when the speaker turns their head from side to side. Placing the microphone 6 inches away from the mouth will also achieve the best sound quality.
5. When using the headset microphone, consideration must be used with it’s placement as well. The microphone should be placed off the corner of the mouth to achieve the best signal. If the microphone is “popping” with the pronunciation of plosive words (such as pop, please, Bob, etc.) move the microphone away from the mouth to reduce this occurrence.
6. When connecting or disconnecting the guitar/bass cable to your instrument, make sure that the output of the instrument is turned to zero otherwise you will have extremely loud noises coming from your amp/speakers that could potentially damage them.

## Setting the gain structure of the Bodypack:

The Audix RAD360BP has a variable gain control and three position pad switch on the back of the Bodypack. From the factory the Bodypack will be set with the pad at 0 and the gain in the 12:00 position. This should be the correct position when using either the lavalier or headset options. To increase the output of the Bodypack, using the supplied screw driver, turn the gain control slowly to the right, or clockwise. To decrease the output, turn the gain to the left, or counterclockwise. Care should be given when changing the gain, or output, of the Bodypack as feedback or distortion can occur very quickly.

When using the guitar/bass option, the settings should be as follows: The pad should be set at -20 and the gain turned counterclockwise until it stops. Adjustments can be made using only the gain control from this point depending on the sound that you are looking for. Care should be given in changing the gain too rapidly as feedback or distortion can occur very quickly.

## Storage and care of the RAD360BP:

When not in use, disconnect the microphone from the Bodypack using the above referenced directions, see item #1. Do not wrap the microphone cord around the Bodypack as this will eventually damage the wires and connectors. If you are not going to be using the Bodypack for a length of time, Audix recommends that the batteries should be removed from the unit.

## Quick Trouble Shooting Guide for the Bodypack:

<b><u>Problem</u></b>	<b><u>Possible solution</u></b>
Little or no sound	<ul style="list-style-type: none"><li>▶ Make sure the Bodypack has fresh batteries.</li><li>▶ Move the microphone closer to the mouth of the speaker.</li><li>▶ Increase the gain of the Bodypack.</li><li>▶ Make sure the transmitter is turned on.</li></ul>
Crackling	<ul style="list-style-type: none"><li>▶ Clean the connector on both the Bodypack and mic cable connector using a high quality cleaner such as De-Oxit™. If the problem persists, please contact Audix customer service for assistance.</li></ul>
Popping	<ul style="list-style-type: none"><li>▶ Move the microphone away from the mouth.</li></ul>

## Using the Scan Feature on the RAD-360 Receiver

To simplify setup, The RAD 360 is equipped to scan for working transmitters so that one person can easily setup the system, even at a distance.

1. From the startup screen, press and hold the SET button until you see the word "FREQUE".

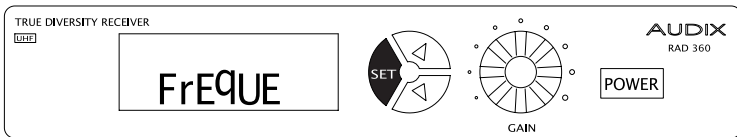

2. Press SET once again and you will see "Scan" on the display.

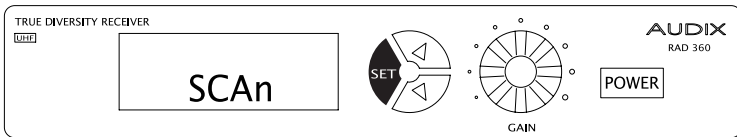

3. Press either UP or DOWN and the RAD 360 will look for operating transmitters' frequency. \*NOTE\* A transmitter **must** be turned on for the receiver to find it.

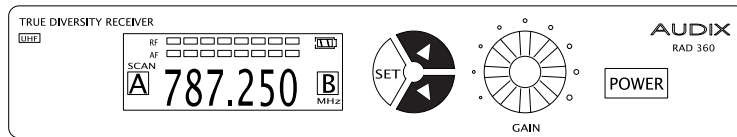

4. Press SET to save settings.

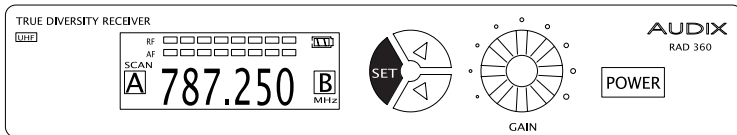



## Battery Life Indicators

The Audix RAD 360 wireless system features a battery indicator display on both the transmitter and receiver. The following guide will help you determine the length of time the system will operate until the batteries need replacement. This is only a guide as different batteries and conditions may cause variations. Always use fresh batteries of the same make for optimum results.



15-10.5 hours



10.5-6 hours

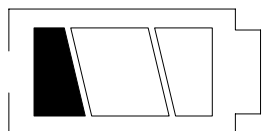

6-2.5 hours

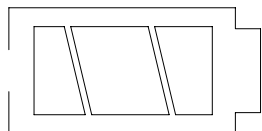

< 2.5 hours

## PERFORMANCE TIPS:

The following are some tips to help ensure the best possible sound and performance from your Audix RAD 360 Wireless Mic.

- 1) Whenever possible maintain “line of sight” for the system. In other words, the system will work best if there is an unobstructed path between the transmitter and the antennas of the receiver. Burying the receiver in the back of your rack is not the recommended way to ensure optimal reception. However, it does not mean that you will have a loss of signal (also known as drop-out) if the receiver is blocked in some way. It does mean the chances of having drop-out will increase. Audix transmitters broadcast at 50mW, a high level of RF power. If you do choose to place your receiver in an equipment rack, it is recommended that you use the option to bring your antennas around to the front of the receiver or use our remote antenna option.
- 2) The Audix RAD 360 you have purchased is a true diversity system; inside the receiving unit there are separate receivers for each antenna. The system automatically silently switches back and forth between the two receivers to pick the one that has the best signal and sends that to the output jack. Because of this, you should NEVER operate your system with only one antenna. When using the system, the antennas should be in an upright position at a 45 degree angle to each other to ensure the best possible reception.
- 3) Avoid placing the receiver near other RF generating products such as amplifiers or computers.
- 4) When remote placing the antennas, a rule of thumb is that you should have no more than a 25 foot cable run from the antenna to the receiver. This will ensure that you have minimal signal line loss from the antenna to the receiver. Audix recommends when remoting your antennas to use a low signal loss cable such as RG-58u, an industry standard.
- 5) Do not put anything in front of your antennas as this can hinder the performance of your system and lead to drop outs.
- 6) Do not block the transmitter antenna with your hands or heavy clothing

- 7) If in doubt, use new batteries. The Audix RAD 360 system uses the most current technology to ensure you get the most life from your batteries. In fact, our transmitters will continue to broadcast at 50mW right up until the end of the battery life when the broadcast distance and sound quality will drop off dramatically. To ensure the best performance, new batteries are always recommended and encouraged. You should get approximately 12-15 hours of battery life when using alkaline batteries. Rechargeable batteries such as, NiCad and NiMH, have a much shorter usage time. Audix suggests having two sets of rechargeable batteries and rotating them for each performance or set
- 8) When using a lavalier microphone, the rule of placement to follow is to put the mic 6 inches below the mouth, and centered. Unlike the TV station that has the mic placed at the reporter's navel, you have the challenge of working with live sound coming from the speakers in the room. Placing the lavalier too far from the mouth will lead to a low signal. Turning up the gain to hear what is being said will dramatically increase the chance of feedback in your system. By placing the mic in the proper position, you will also lessen the "racetrack" effect when the speaker turns their head from side to side.
- 9) Audix also offers a headset microphone. To ensure best performance, make sure to position the mic at the corner of the mouth. This will reduce the amount of "pops" that will happen when the speaker pronounces words with plosives.
- 10) Do not set two transmitters to the same frequency – it will not work! At best you will cancel out the signal; at worst your sound system will squeal loudly.
- 11) Both the handheld and Bodypack transmitters have an adjustable sensitivity setting of 0dB, -6dB, -12dB, and -24dB. This is to give you the best gain before feedback, and also avoid overloading your amp or mixer. Audix ships the RAD 360 systems at a -12dB position. For a particularly strong vocalist or speaker, it may be necessary to "pad" the mic to -30 dB. This feature may also be useful in a particularly noisy environment.
- 12) The more wireless mics you use in an area, the more chance you have for interference between the systems because of the additional frequencies. This does not mean that you cannot use multiple RAD 360 systems in one location. To the contrary, Audix designed the RAD 360 to be compatible with upwards of 12-16 wireless systems in one location. Contact your Audix representative at 1-800-966-8261 to assist you in the determination of which frequencies can best be used at the same time in your particular location.

## **TROUBLESHOOTING:**

The following is a list of the most common problems you may experience.

<b><u>Problem</u></b>	<b><u>Possible solution</u></b>
No signal	<ul style="list-style-type: none"><li>▶ Replace batteries.</li><li>▶ Be sure the transmitter and receiver are on the same frequency.</li><li>▶ Be sure both units are turned on.</li><li>▶ Be sure the receiver is plugged in and getting power.</li><li>▶ Move the transmitter closer to the receiver.</li></ul>
RF but no Audio (AF)	<ul style="list-style-type: none"><li>▶ The board has been muted.</li><li>▶ The lavalier is not correctly connected to the Bodypack.</li><li>▶ Make sure your cables are connected to the sound board.</li></ul>
Distortion	<ul style="list-style-type: none"><li>▶ Engage the -6dB, -12dB, or -24dB pad on the transmitter.</li><li>▶ Hold the mic further away from your mouth.</li><li>▶ Move the lavalier away from your mouth.</li><li>▶ Move the headset away from your mouth.</li><li>▶ If you have more than one wireless system in use, make sure they are not set on the same frequency.</li><li>▶ Move away from the receiver.</li></ul>
Weak signal	<ul style="list-style-type: none"><li>▶ Be sure you have fresh batteries.</li><li>▶ Either move the transmitter closer to the receiver or remote your antennas closer to the transmitter.</li></ul>

*As noted above, these are some common problems. If you find other questions regarding troubleshooting that are not answered here, please contact your Audix representative for assistance at 1-800-966-8261.*

# specifications

<b>Frequency Range</b>	638 MHz–804 MHz
<b>Switchable Frequencies</b>	193 (per system group of 24 MHz spaced .125 Hz apart)
<b>Freq Response</b>	40 Hz–18 kHz (depending on capsule)
<b>Signal To Noise Ratio</b>	>110dB
<b>Comander System</b>	HDX
<b>Pilot Tone</b>	32.768 kHz
RAD360-R	
<b>Receiving System</b>	Dual tuners, true diversity receiver
<b>Image Rejection</b>	50 dB nominal, 45 dB minimum
<b>Signal-to-noise Ratio</b>	110 dB at 30 kHz deviation (IEC-weighted), maximum modulation 75 kHz
<b>Total Harmonic Distortion</b>	≤ 1% (10 kHz deviation at 1 kHz)
<b>Sensitivity</b>	26 dB $\mu$ V (S/N 60 dB at 5 kHz deviation, IEC-weighted) <2.5 $\mu$ V
<b>Intermediate Frequency</b>	55.875 MHz, 10.7 MHz
<b>Audio Output</b>	Unbalanced: 40 mV (at 1 kHz, 10kHz deviation, 10k ohm load) (AF Level set at "0") Balanced: 8mV (at 1 kHz, 10kHz deviation, 600 ohm load)
<b>Output Connectors</b>	Unbalanced: 1/4" phone jack Balanced: XLR
<b>Nominal Peak Deviation</b>	Balanced: -24 to +18dBu Unbalanced: -30 to +12dBu (adjustable in 6 dB-steps)
<b>Adjacent Channel Rejection</b>	>68dB
<b>Intermodulation Spacing</b>	>68dB
<b>Image Rejection</b>	>72dB
<b>Power Supply</b>	120V AC 60 Hz; 12-18V DC, 350 mA, with external supply
<b>Dimensions</b>	8.35" (W) x 1.1" (H) x 6.5" (D) 212mm (W) x 38mm (H) x 165 mm (D)
<b>Net Weight</b>	2.32 lbs/1050 g
RAD360-T Handheld Microphone Transmitter	
<b>RF Power Output</b>	50 mW Max
<b>Spurious Emissions</b>	Under federal regulations
<b>Battery (not included)</b>	2- AA 1.5 V
<b>Current Consumption</b>	100 mA typical
<b>Battery Life</b>	Approximately 12 hours (depending on battery type and usage)
<b>Max Sound Pressure Level</b>	>140 dB (depending on capsule)
<b>Dimensions</b>	1.3" diameter body, 2.1" diameter grill x 9.4" (L) 33 mm diameter body, 53.4 mm diameter grill x 238.67 mm (L)
<b>Net Weight (without battery)</b>	12.35 oz/350 g

## Supplied Accessories

- **RAD-ANT1** 3/4 Wave UHF whip antenna (2)
- **RAD-PS110** DC power supply (110 VAC, 12V–350 milliamp,)
- **RAD-CC360** Zippered carrying case
- **RAD-MC360T** Microphone clip for handheld transmitter

## Optional Accessories

- **RAD-RM1** Rack mount kit for 1 -RAD360R
- **RAD-RM2** Rack mount kit for 2 -RAD360R
- **RAD-CBL1** 3' antenna extension cable with BNC connectors
- **RAD-ADS4** Antenna distribution system (for up to 4 systems)
- **RAD-AB1** UHF Antenna booster
- **RAD-CBL3** 3' Guitar cable for bodypack

## System Components

- **RAD-360R** UHF true diversity receiver
- **RAD360BP** UHF bodypack
- **RAD-360T** UHF hand held transmitter (without capsule assembly)
- **RAD360T3** UHF Handheld transmitter with OM3 capsule
- **RAD360T5** UHF Handheld transmitter with OM5 capsule
- **RAD360T6** UHF Handheld transmitter with OM6 capsule
- **RAD360T7** UHF Handheld transmitter with OM7 capsule
- **RAD-CPS2** OM2 Capsule assembly for handheld transmitter
- **RAD-CPS3** OM3 Capsule assembly for handheld transmitter
- **RAD-CPS5** OM5 Capsule assembly for handheld transmitter
- **RAD-CPS6** OM6 Capsule assembly for handheld transmitter
- **RAD-CPS7** OM7 Capsule assembly for handheld transmitter

## Lavalier and specialty microphones for RAD360 Bodypack

- **ADX5-NP** ADX5 black omni lavalier with 3' cable (3 pin mini-XLR)
- **ADX5B-NP** ADX5 beige omni lavalier with 3' cable (3 pin mini-XLR)
- **ADX10-NP** ADX10 cardioid lavalier with 3' cable (3 pin mini-XLR)
- **HT2-NP** HT2 headset mic with 3' cable (3 pin mini-XLR)
- **ADX20i-NP** ADX20i Instrument mic with 3' cable (3 pin mini-XLR)

RAD360-BP Bodypack Transmitter	
<b>RF Power Output</b>	50 mW Max
<b>Spurious Emissions</b>	Under federal regulations
<b>Input Connector</b>	3 pin mini-XLR
<b>Input Controls</b>	Mic/line switch, and 20 dB potentiometer
<b>Battery</b> (not included)	2- AA 1.5 V
<b>Current Consumption</b>	100 mA typical
<b>Battery Life</b>	Approximately 12 hours (depending on battery type and usage)
<b>Input Impedance</b>	Mic: 10kOhm Line: 1M0hm
<b>Max Sound Pressure Level</b>	approx. 128–140dB (depending on mic)
<b>Dimensions</b>	2.8" (W) x 4" (L) x 1"(D) 71.3 mm (W) x 104 mm (L) x 27 mm(D)
<b>Net Weight</b> (without battery)	7.5 oz/212 g

# Measurements

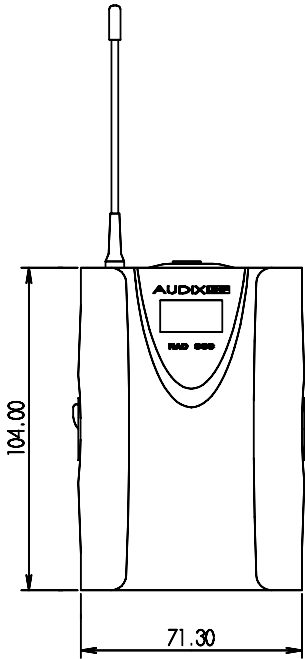

Measurement in Millimeters

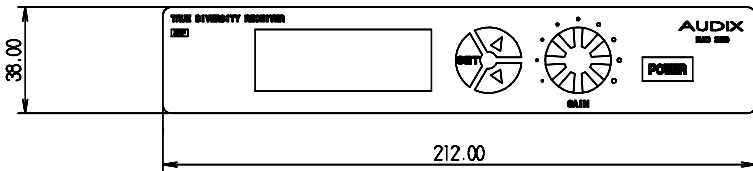
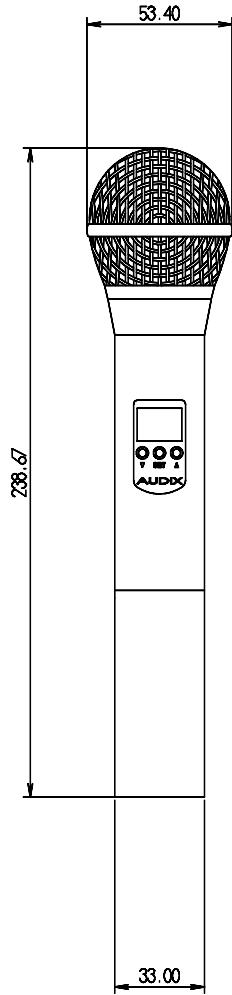

# AUDIX.

**CALL: 503-682-6933 • FAX: 503-682-7114 • [www.audixusa.com](http://www.audixusa.com)**

Specifications subject to change without notice.

Audix Corporation PO Box 4010, Wilsonville, OR 97070 . In Canada, Cabletek Electronics LTD, 604-942-1001 fax 604-942-1010  
©Audix Corporation 2004. All rights reserved. Audix and the Audix logo are trademarks of Audix Corporation.